

# PC机箱电源演进

——Necokeine

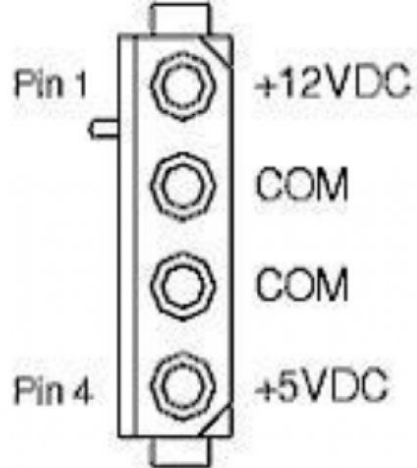

硬盘、光驱电源接口



软驱电源接口

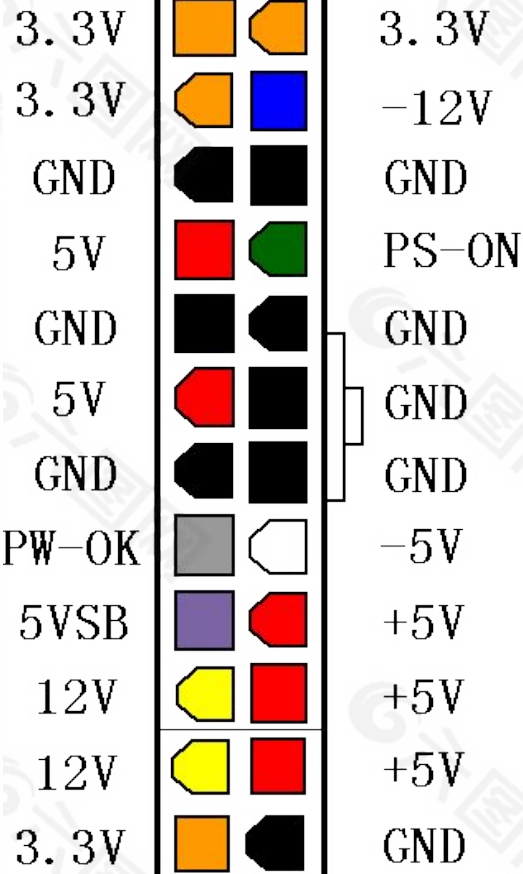
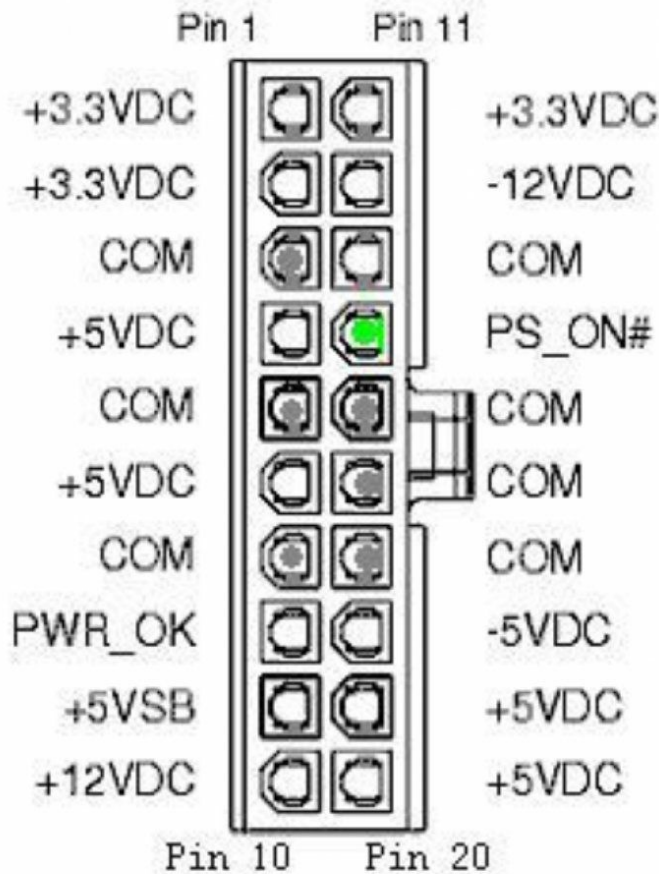

ATX主板电源接口

12 24

← 140mm →



ATX

150x86x140mm

← 125mm →



SFX-L

125x63,5x125mm

← 100mm →



SFX

125x51.5x100mm

# 长ATX电源

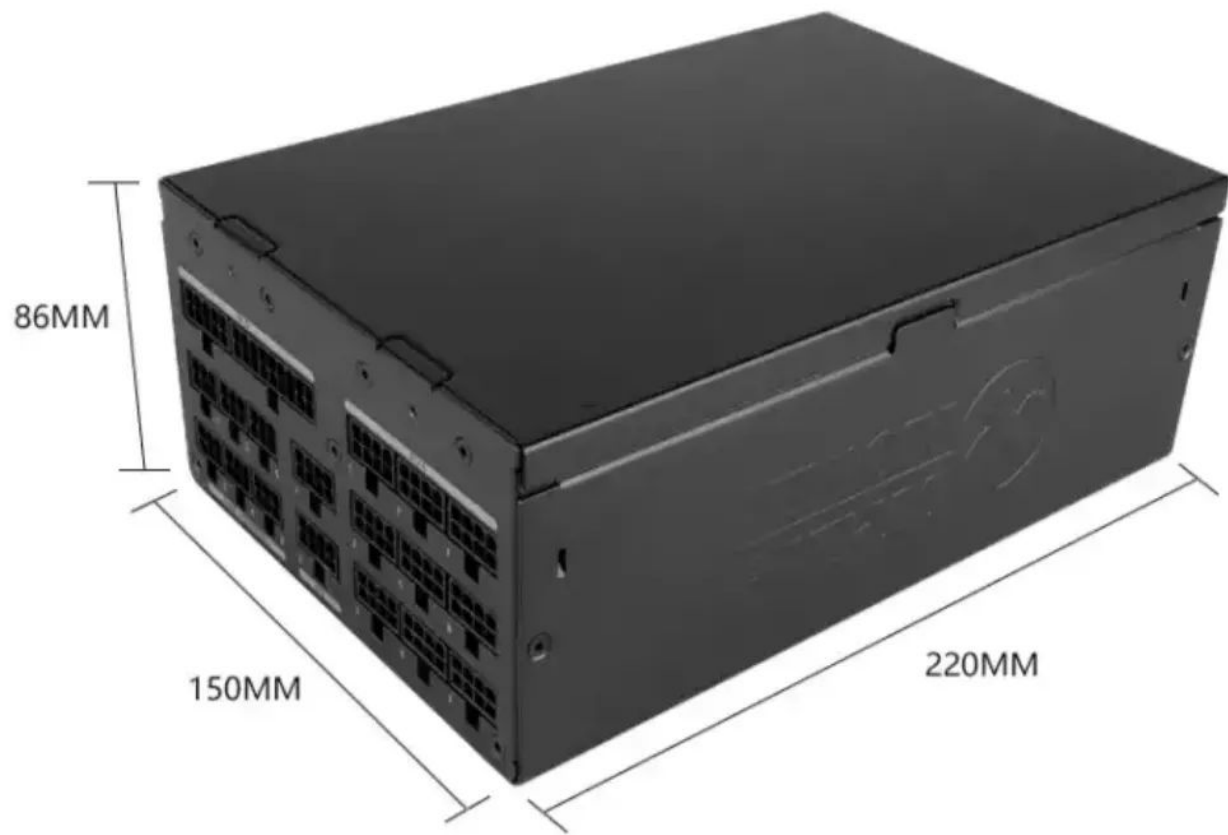

## ATX 时代的电源历史



4-Pin Molex

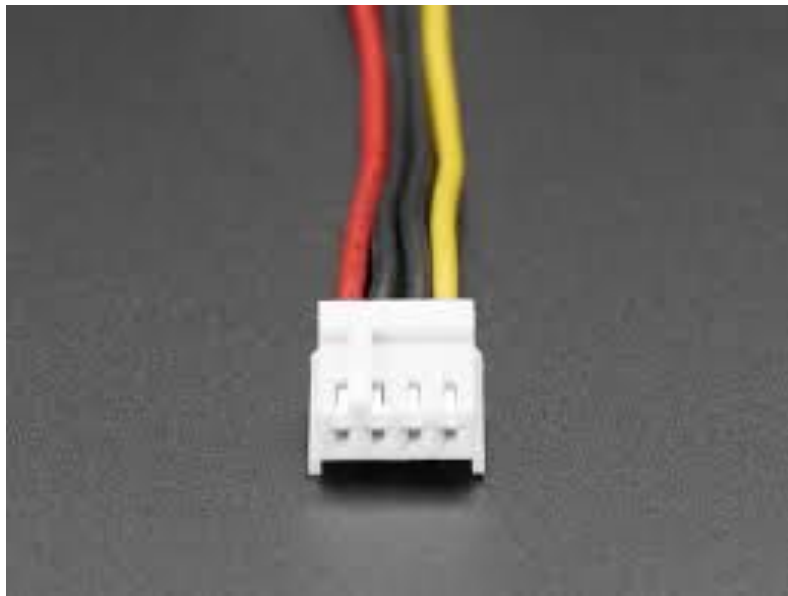

4-Pin Berg floppy connector

# ATX12V标准

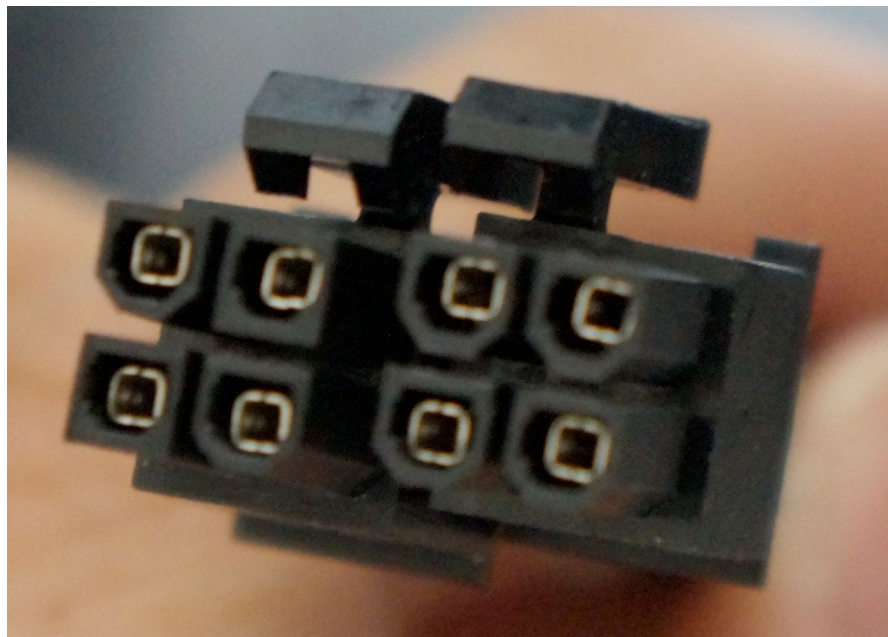
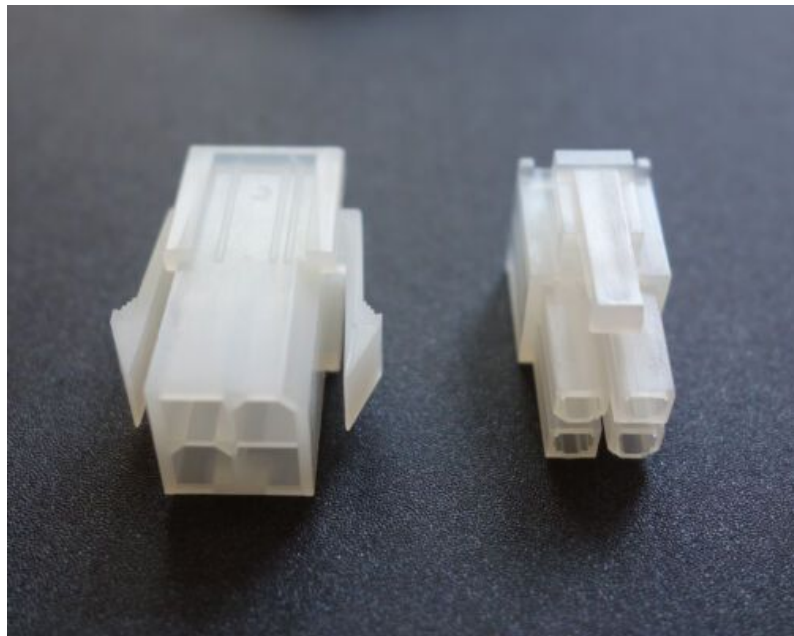

Molex 39-01-2040

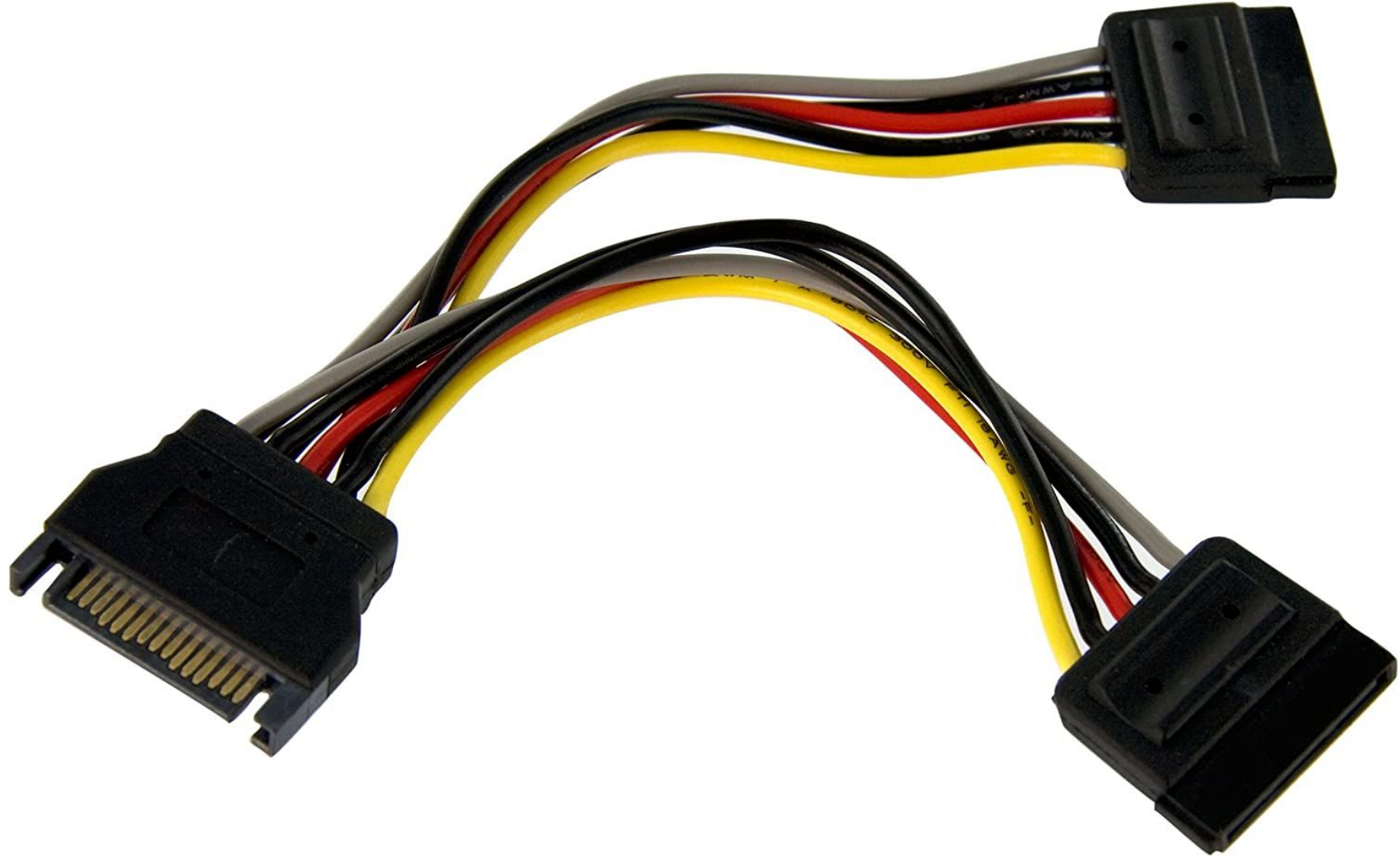



# ATX12VO





# ATX12V 3.0

Figure 5-1: 12VHPWR Connector Labeling Example



Figure 5-3: 12VHPWR Cable Plug Connector

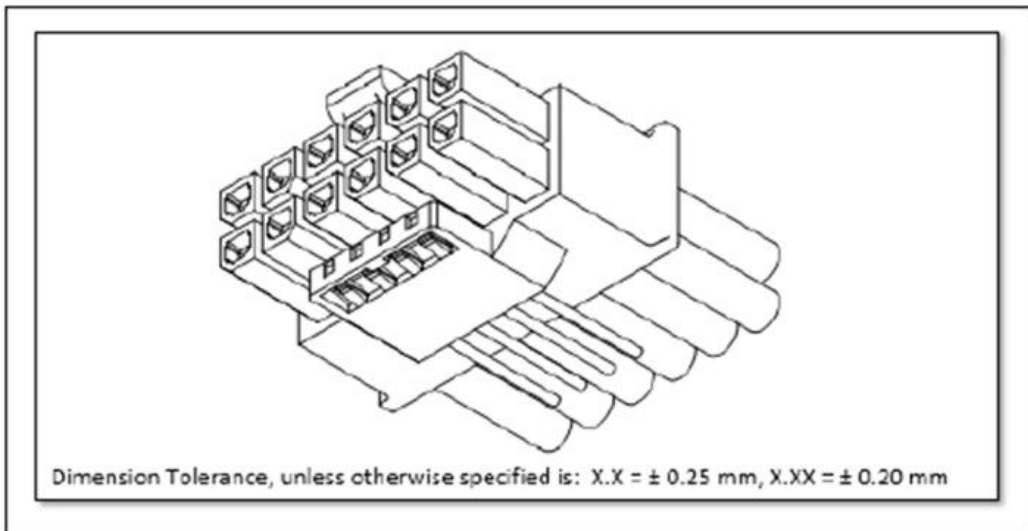

Thanks